

TECHNICAL DATA SHEET

3-DOOR TELESCOPIC (NO FLOOR TRACK)

Hawa Junior 80 Z Telescopic 80/3



- > For 3 bypassing sliding wood doors
- > Door weight per panel: max. 80 kg (176 lbs.)
- > Door thickness: 40–47 mm (1 9/16"–1 7/8")
- > Door width: 500–1200 mm (19 11/16"–47 1/4")
- > Smooth, quiet operation
- > Outstanding durability
- > Rattle-free bottom guide
- > Parallel opening and closing of 3 sliding doors
- > Special two-way suspension
- > Vertically and laterally adjustable
- > Door stop with adjustable retention spring

Door width (DW) calculation

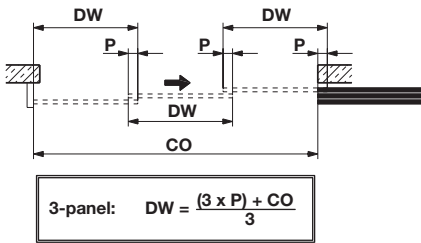

Upper track length calculation:

80/3 $L = CO + DW$

- DW** = Door width
- CO** = Clear opening
- P** = Overlap
- P** = ≥ 75 mm (2 15/16")

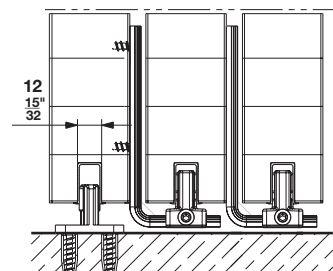
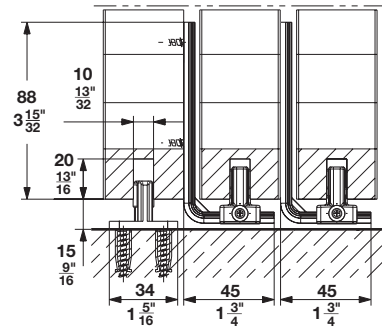
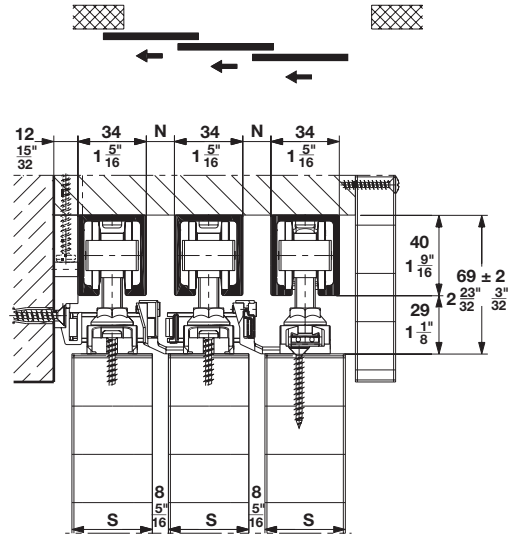

With optional guide rails

S = Door thickness

N = Distance between upper tracks based on door thickness

$N = S - 26$ mm (1")

For any additional information please contact:

Ty LeFever | Tel: (815) 315-3410 | Email: hospitality@hafele.us

TECHNICAL DATA SHEET (continued)

Hawa Junior 80 Z Telescopic 80/3 Set

	Model	Door weight	Supplied with	Item No.
Supplementary fitting set for 3 sliding doors	Telescopic 80/3	≤ 80 kg (88 lbs.)	4 pulleys (2 long, 2 short) 1 toothed belt mounting device (ceiling/wall mounted) 2 toothed belts (2 at 2.7 m) 3 drivers for toothed belts (1 narrow, 2 wide) 1 driver plate 1 lower guide – Confort 120 1 lower guide for guide channel	940.81.008

Note

In addition, order these separately: **3 upper tracks**
3 sets of Hawa Junior 80 Z
1 Confort 120 guide
3 guide rails (optional)

Hawa Junior 80 Z Set

Model	Door weight	Supplied with	Item No.
Junior 80/Z	≤80 kg (176 lbs.)	2 running gears 2 suspension plates incl. suspension M10 bolts, set nuts, and mounting screws 1 track stopper, with retaining spring 1 wall buffer 1 rattle-free floor guide 1 height adjusting pin	940.80.001

→ Tracks and Accessories

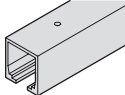
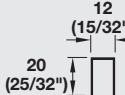
Description		Material	Finish	Length	Item No.
Upper track, pre-drilled		Aluminum	clear anodized	1.4 m (4' 7 1/8")	940.80.140
				1.6 m (5' 3")	940.80.160
				1.8 m (5' 10 7/8")	940.80.180
				2 m (6' 6 3/4")	940.80.200
				2.2 m (7' 2 5/8")	940.80.220
				2.5 m (8' 2 7/16")	940.80.250
				3 m (9' 10 1/8")	940.80.300
				4 m (13' 1 1/2")	940.80.400
Guide rail, glue-in type (optional)		Plastic	black	1.3 m (4' 3 3/16")	940.41.130

Installation Plan

(Included in fitting set), mounting instructions for planning and execution available upon request.

→ Confort 120

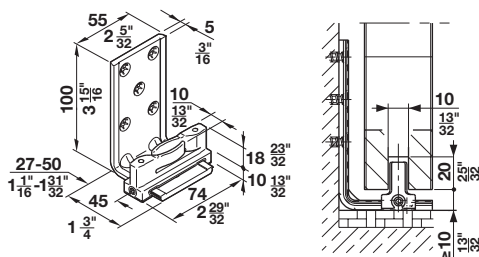

- > Laterally adjustable
- > Wall mounted
- > Rattle-free
- > Door weight: max. 120 kg (264 lbs.)
- > Groove size: 10 mm (13/32")
- > Material: Bracket: Aluminum, anodized
Guide: Plastic; Color: black

Item No.
940.40.070