

Traditions Collection – Corbels

- Top profile accepts moulding up to 3/4"
- Use with room decorations, islands, etc.
- Produced from laminated stock and wood, each corbel is color matched
- Within a color match there may be slight variation of color from white to light gray or light brown
- If using keyhole plates to mount corbels, use #8 or larger screws
- Designed to complement onlays, mouldings and feet on following page

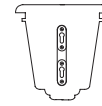

Corbels can be mounted with keyhole plates provided and pre-attached.

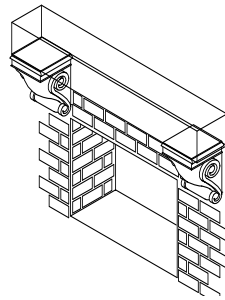
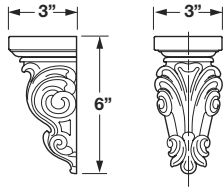
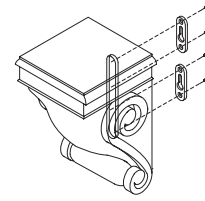

Wood species	Item No.
Maple	198.04.170
Oak	198.04.470
Cherry	198.04.670

*Packing: 2 pcs.

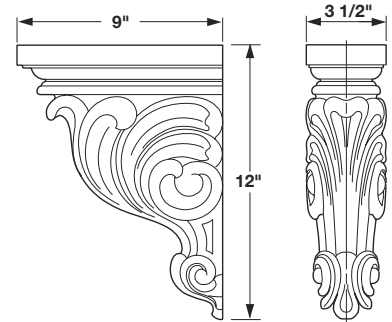

Wood species	Item No.
Maple	198.04.190
Oak	198.04.490
Cherry	198.04.690

Packing: 1 pc.

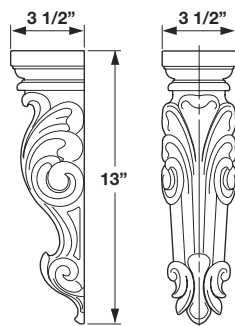

Wood species	Item No.
Maple	198.04.180
Oak	198.04.480
Cherry	198.04.680

Packing: 1 pc.

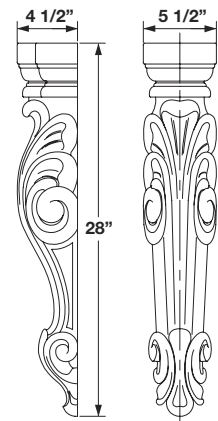

Wood species	Item No.
Maple	198.00.132
Oak	198.00.432
Cherry	198.00.632

Packing: 1 pc.

*Minimum order quantity is 1 piece.

Dimensions in Inches

Traditions Collection – Onlays, Mouldings and Bunn Feet

• Designed to complement corbels on preceding page

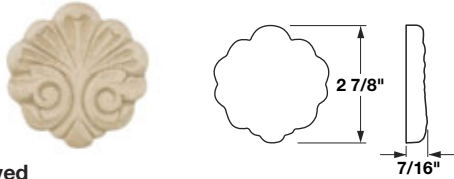

Carved

Wood species	Item No.
Maple	198.03.180
Oak	198.03.480
Cherry	198.03.680

*Packing: 10 pcs.



Carved

Wood species	Item No.
Maple	198.03.170
Oak	198.03.470
Cherry	198.03.670

*Packing: 10 pcs.



Carved, 96" long

Wood species	Item No.
Maple	198.02.160
Oak	198.02.460
Cherry	198.02.660

Packing: 1 pc.

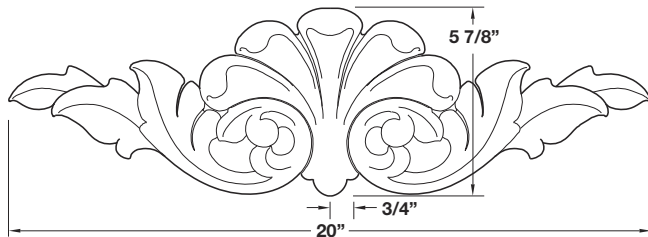

Carved

Wood species	Item No.
Maple	198.01.140
Oak	198.01.440
Cherry	198.01.640

*Packing: 10 pcs.



Carved

Wood species	Item No.
Maple	198.16.180
Oak	198.16.480
Cherry	198.16.680

Packing: 1 pc.

Dimensions in Inches

***Minimum order quantity is 1 piece.**