

*B*EAUTIFULLY SIMPLE, SIMPLY
BEAUTIFUL, ARTS AND CRAFTS
INSPIRED DESIGN.

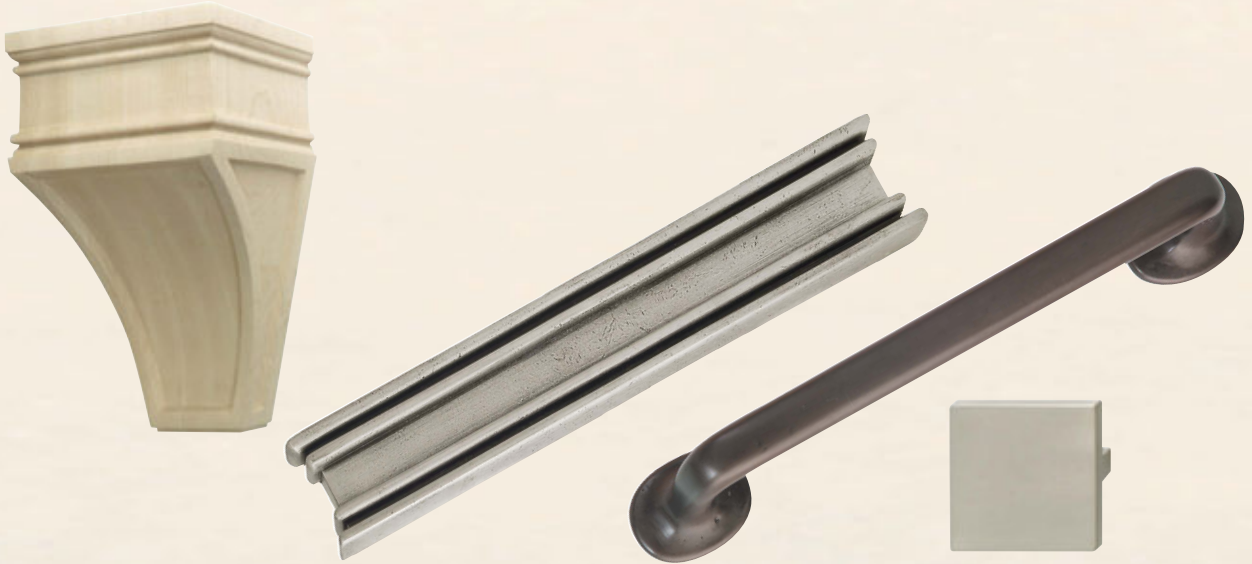

ARCADIAN

COLLECTION

SLEEKLY SOPHISTICATED HARDWARE COMPLEMENTS THE UNDERSTATED
STYLE OF THE WOOD SELECTION TO SUIT TRADITIONAL, TRANSITIONAL
AND CONTEMPORARY TASTES.

Arcadian Collection – Corbels

- Designed to complement onlays, mouldings and posts on pages **9-10**
- Use with mantels, room decorations, islands, etc.
- Details are hand-carved
- If using keyhole plates to mount corbels use #8, or larger screws
- Produced from laminated stock and wood, each corbel is color matched
- Within a color match there may be slight variation of color from white to light gray or light brown
- Matching handles and knobs can be found on pages **11-13**

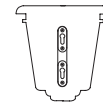
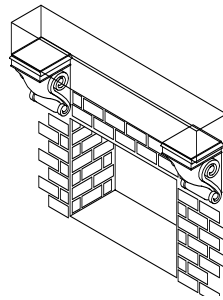

Corbels can be mounted with keyhole plates provided and pre-attached.

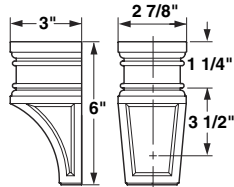
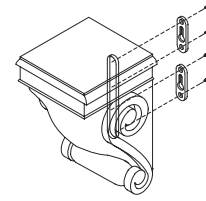

Hand Carved

Wood species	Item No.
Maple	198.04.150
Oak	198.04.450
Cherry	198.04.650

*Packing: 2 pcs.

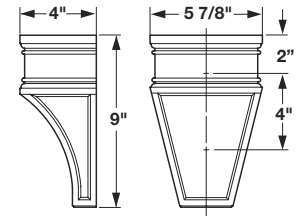

Hand Carved

Wood species	Item No.
Maple	198.04.140
Oak	198.04.440
Cherry	198.04.640

Packing: 1 pc.

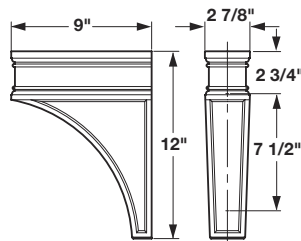

Hand Carved

Wood species	Item No.
Maple	198.04.130
Oak	198.04.430
Cherry	198.04.630

Packing: 1 pc.

Other species available. Minimum 100 piece order. Ask for details.

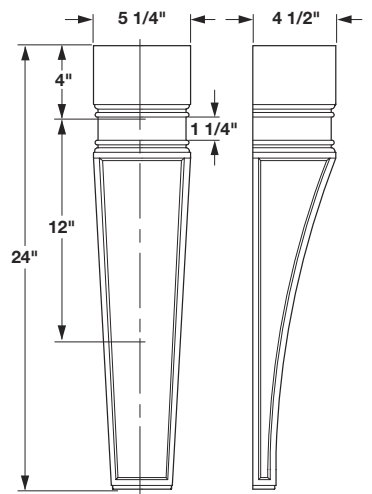

Hand Carved

Wood species	Item No.
Maple	198.04.160
Oak	198.04.460
Cherry	198.04.660

Packing: 1 pc.

Dimensional data not binding. We reserve the right to alter specifications without notice.

***Minimum order quantity is 1 piece.**

Dimensions in Inches

Arcadian Collection – Onlays and Mouldings

- Highly detailed
- Hand-carved
- Designed to complement corbels and posts on pages 8 & 10
- Matching handles and knobs can be found on pages 11-13

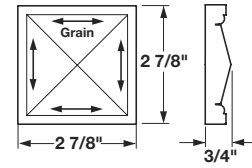

Hand Carved

Wood species	Item No.
Maple	198.07.121
Oak	198.07.421
Cherry	198.07.621

*Packing: 10 pcs.

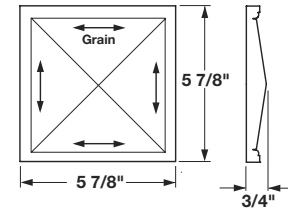

Hand Carved

Wood species	Item No.
Maple	198.07.122
Oak	198.07.422
Cherry	198.07.622

*Packing: 10 pcs.

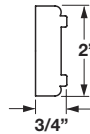

Hand Carved, 96" long

Wood species	Item No.
Maple	198.06.110
Oak	198.06.410
Cherry	198.06.610

*Packing: 1 pc.

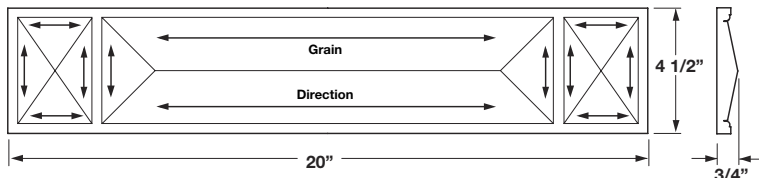

Hand Carved

Wood species	Item No.
Maple	198.05.110
Oak	198.05.410
Cherry	198.05.610

*Packing: 10 pcs.

Dimensional data not binding. We reserve the right to alter specifications without notice.

Other species available. Minimum 100 piece order. Ask for details.

***Minimum order quantity is 1 piece.**

Dimensions in Inches

Arcadian Collection – Posts

- Designed to complement corbels and mouldings on preceding pages
- Matching handles and knobs can be found on pages 11-13

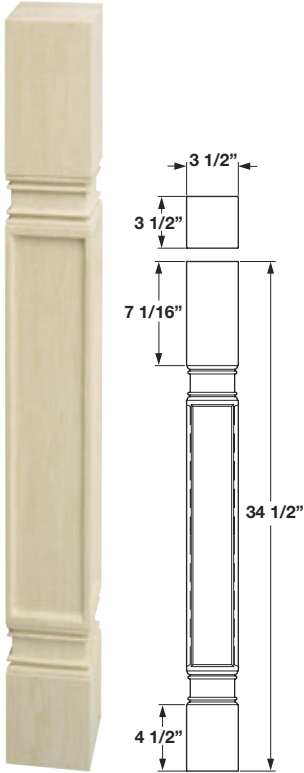

Hand Carved

Wood species	Item No.
Maple	635.74.120
Oak	635.74.420
Cherry	635.74.620

Packing: 1 pc.

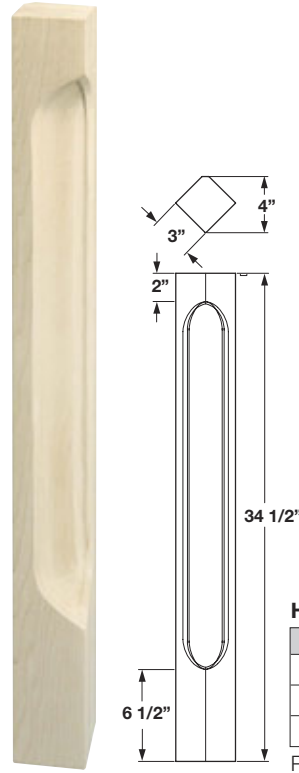

Hand Carved Corner Post

Wood species	Item No.
Maple	635.50.178
Oak	635.50.478
Cherry	635.50.678

Packing: 1 pc.

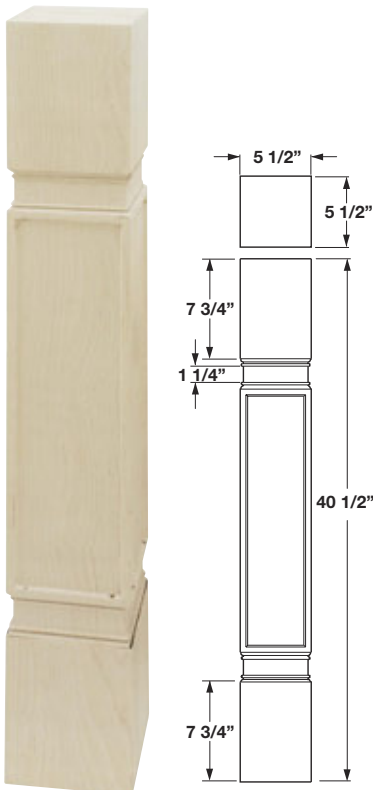

Hand Carved

Wood species	Item No.
Maple	635.74.170
Oak	635.74.470
Cherry	635.74.670

Packing: 1 pc.

Other species available. Minimum 100 piece order. Ask for details.

Arcadian Transitional Collection

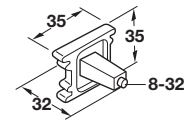

Pewter, satin

	Item No.
	123.25.900

Packing: 1 pc.

Pewter, bronze

	Item No.
	123.25.100

Packing: 1 pc.

Pewter, bronze rubbed

	Item No.
	123.25.300

Packing: 1 pc.



•123.25.908 includes 1/4-20 x 25 mm mounting screws

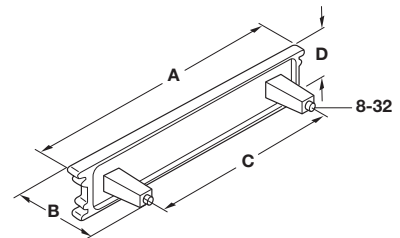

Pewter, satin

A x B x D	C	Item No.
122 x 25 x 33	3"	123.25.901
178 x 26 x 42	128 mm	123.25.902
264 x 36 x 43	8"	123.25.904
372 x 46 x 43	12"	123.25.908

Packing: 1 pc. (includes 8-32 x 25 mm screws)



• 123.25.108 includes 1/4-20 x 25 mm mounting screws

Pewter, bronze

A x B x D	C	Item No.
122 x 25 x 33	3"	123.25.101
178 x 26 x 42	128 mm	123.25.102
264 x 36 x 43	8"	123.25.104
372 x 46 x 43	12"	123.25.108

Packing: 1 pc. (includes 8-32 x 25 mm screws)



•123.25.308 includes 1/4-20 x 25 mm mounting screws

Pewter, bronze rubbed

A x B x D	C	Item No.
122 x 25 x 33	3"	123.25.301
178 x 26 x 42	128 mm	123.25.302
264 x 36 x 43	8"	123.25.304
372 x 46 x 43	12"	123.25.308

Packing: 1 pc. (includes 8-32 x 25 mm screws)

Dimensional data not binding. We reserve the right to alter specifications without notice.



1/4-20 screws
8-32 screws

page 280
page 279

Dimensions in mm
Inches are approximate

Arcadian Collection

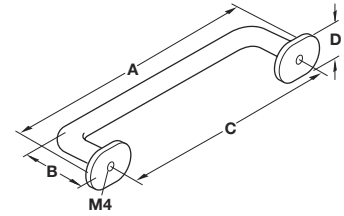

Natural Britannium

A x B x D	C	Item No.
103 x 30 x 20	78	116.61.000
154 x 35 x 22	128	116.61.002
332 x 42 x 25	305	116.61.007
495 x 47 x 32	457	116.61.008

*Packing: 1 and 10 pcs.

- 116.61.007 and 116.61.008 include M6 x 40 mm mounting screws

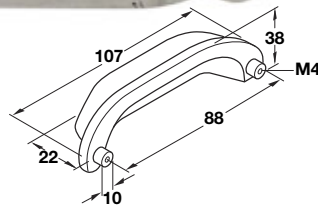

Natural Britannium

Item No.
151.92.880

*Packing: 10 pcs.

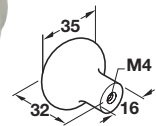

Natural Britannium

Item No.
125.82.900

*Packing: 10 pcs.

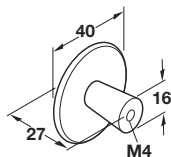

Stainless steel finish

Item No.
134.45.050

*Packing: 50 pcs.

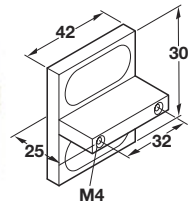
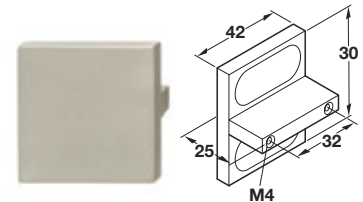

Stainless steel finish

Item No.
106.09.050

*Packing: 50 pcs.



M4 screws
M6 screws

page 279
page 280

Arcadian Collection

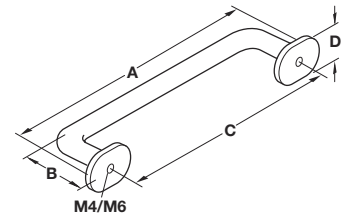

Brass, old bronze

A x B x D	C	Item No.
103 x 30 x 20	78	116.61.100
154 x 35 x 22	128	116.61.102
332 x 42 x 25	305	116.61.107
495 x 47 x 32	457	116.61.108

*Packing: 1 and 10 pcs.

- 116.61.107 and 116.61.108 include M6 x 40 mm mounting screws

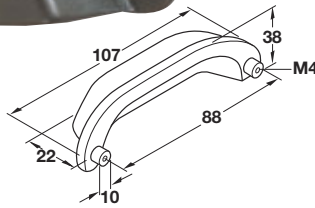

Brass, old bronze

Item No.
151.92.100

*Packing: 10 pcs.

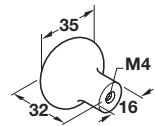

Brass, old bronze

Item No.
125.82.100

*Packing: 10 pcs.

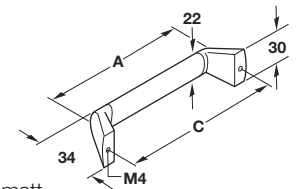

Ends: Zinc, nickel matt
Center: Stainless steel matt

A	C	Item No.
142	128	100.19.601
174	160	100.19.602
206	192	100.19.603
238	224	100.19.604
270	256	100.19.605
334	320	100.19.607
277	392	100.19.608
506	492	100.19.609

*Packing: 15 pcs.

Dimensional data not binding. We reserve the right to alter specifications without notice.



M4 screws
M6 screws

page 279
page 280

***Minimum order quantity is 1 piece.**

Dimensions in mm
Inches are approximate