

Planning guide

Sliding door fittings Flatec IV

for glass doors ($5/16''$ - $1/2''$ thickness)

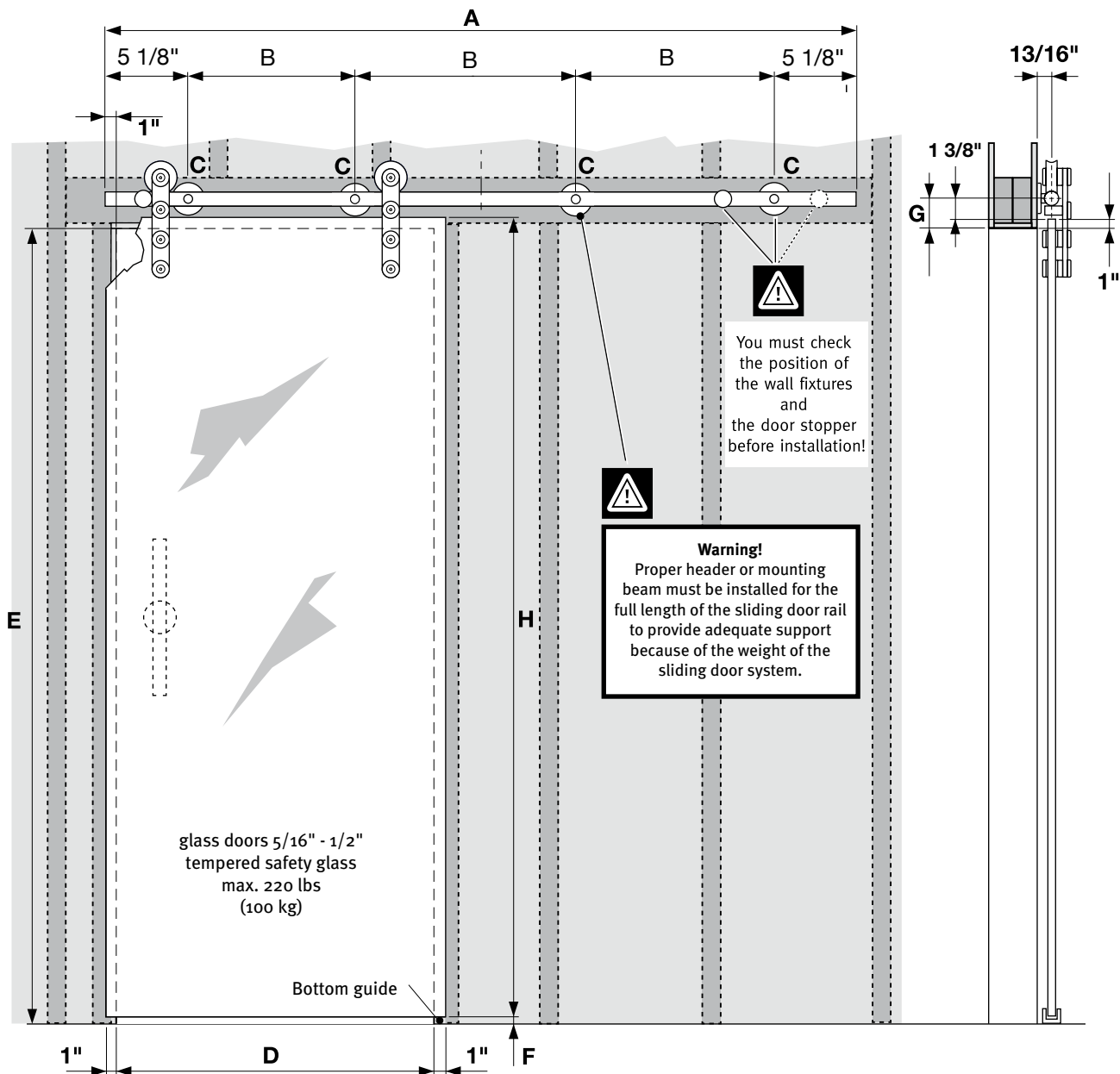

Complete-sets

Set Flatec IV Artikel-No.	A inch	B inch	C Each	D inch	E max. inch	F inch	G inch	H max. inch (H=E-F+1")
USU94-1800EF	70 7/8"	20 1/4"	4	29 1/2" - 35 7/16"	98 7/16"	1/4"-3/8"	2 3/8"	99 1/8"
USU94-2100EF	82 11/16"	24 1/8"	4	35 13/16" - 39 3/8"	98 7/16"	1/4"-3/8"	2 3/8"	99 1/8"
USU94-2300EF	90 9/16"	20 1/16"	5	39 3/4" - 44 1/16"	98 7/16"	1/4"-3/8"	2 3/8"	99 1/8"
USU94-2540EF	100"	22 7/16"	5	44 1/2" - 49 3/16"	98 7/16"	1/4"-3/8"	2 3/8"	99 1/8"

Sliding door fittings Flatec IV

for glass doors (5/16" - 1/2" thickness) - 1 glass door

Manufacturing dimensions (special model)

inches			Each			inches			lbs			Each		
A	B	C	D	D ₁	E	F	G	H	max. 99 1/8" (H = E - F + Y)	load bearing capacity of the guide rail J	L	M	N	
					max. 98 7/16"	1/4"-3/8"		2 3/8"				1	2	2

- A = Guide-rail length
 - B = Drill hole clearance
 - C = Wall fixture
 - D = Passage width
 - D₁ = Door width
 - E = Passage height
 - F = Door - floor clearance
 - G = Fastening clearance
 - H = Door height
 - J = Load-bearing capacity of the guide rail
 - L = Bottom guide
 - M = Door stopper
 - N = Trolley
 - X = Door knob clearance
 - Y = Door height overhang
 - Z = Guide-rail overhang
- () = recommended!

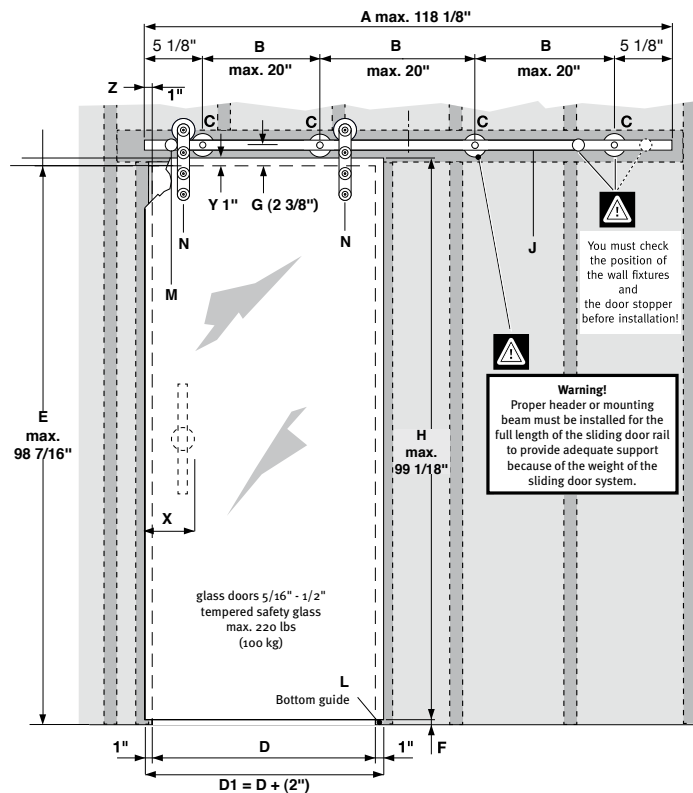

Calculation for guide-rail length A for 1 door

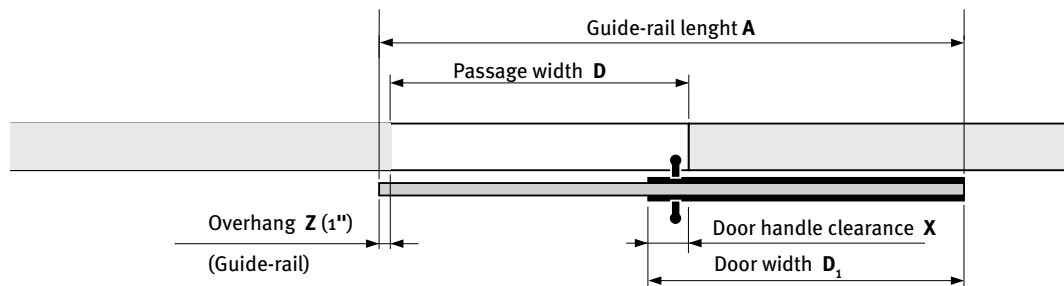

$$\text{Overhang Z} + \text{Passage width D} + \text{Door width D}_1 - \text{Door handle clearance X} = \text{Guide-rail length A}$$



Make door handle clearance so that fingers do not get pinched when the door is used! See page 5.

Sliding door fittings Flatec IV

for glass doors (5/16" - 1/2" thickness) - 2 glass doors

inches		Manufacturing dimensions (special model)										lbs	Each			
A	B1	B2	C	D	D ₁	D ₂	E max. 98 7/16"	F 1/4"- 3/8"	G	H max. 99 1/8" (H = E - F + Y)	load bearing capacity of the guide rail J	K	L	M	N	
									2 3/8"			1	2	4	4	

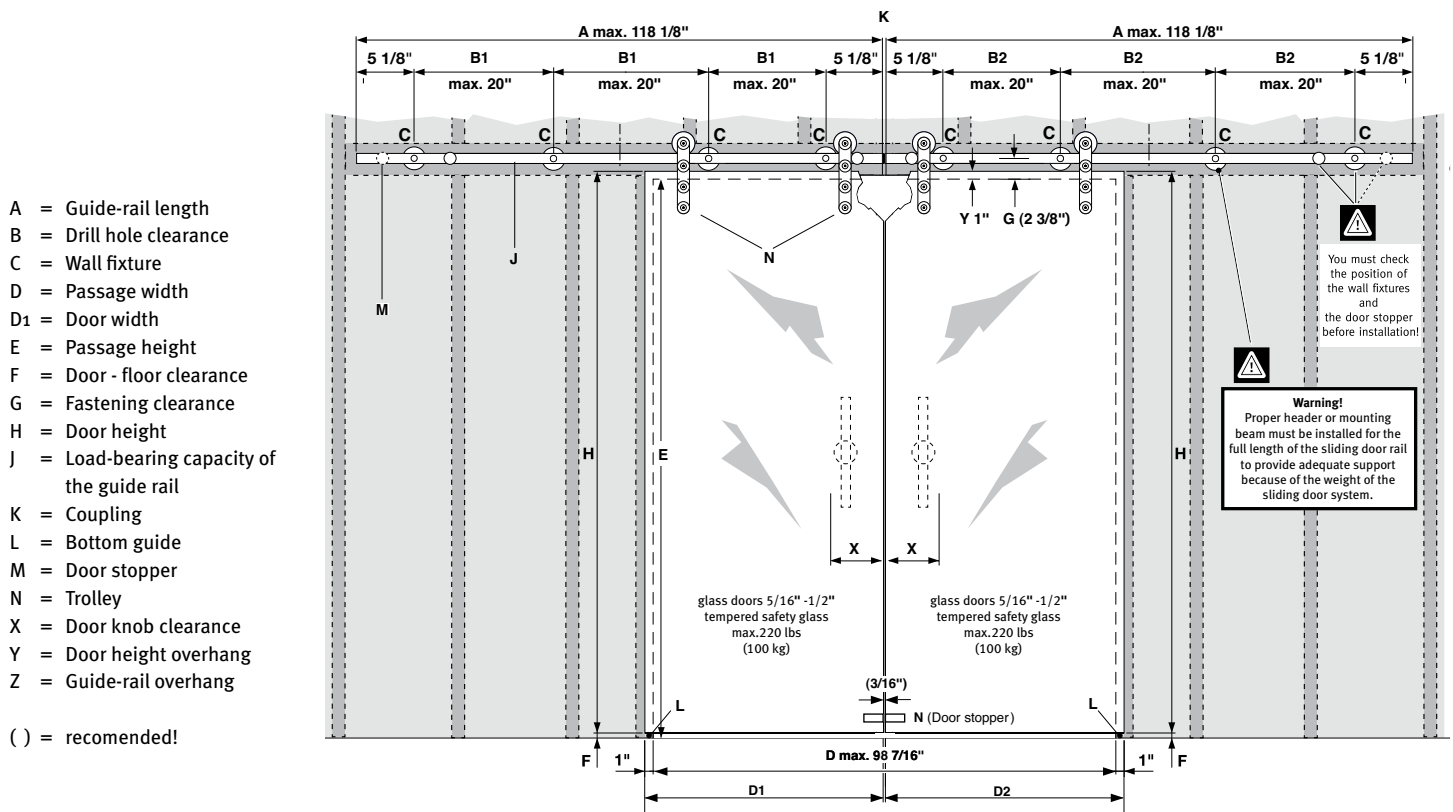

Calculation for total guide-rail length A for 2 doors

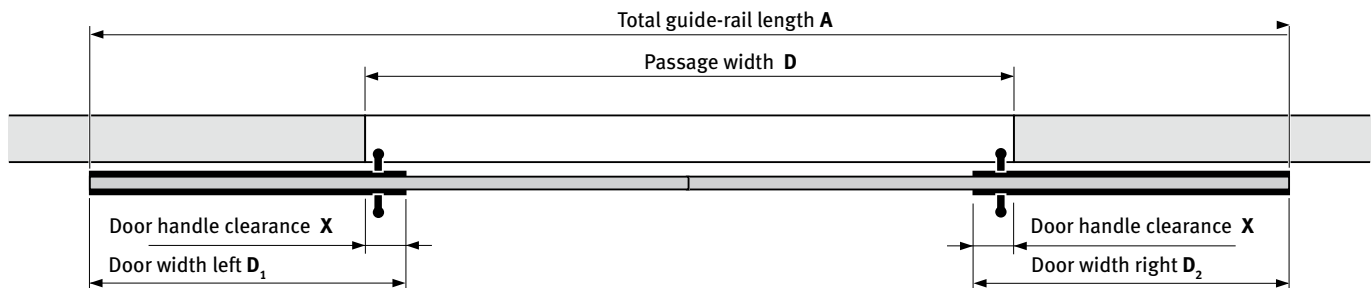

$$\text{Door width } D_1 - \text{Door handle clearance } X + \text{Passage width } D + \text{Door width } D_2 - \text{Door handle clearance } X = \text{Total guide-rail length } A$$



Make door handle clearance so that fingers do not get pinched when the door is used! See page 5.

Sliding door fittings **Flatec IV**

for glass doors ($5/16''$ - $1/2''$ thickness) - Wall fixture

Standard installation

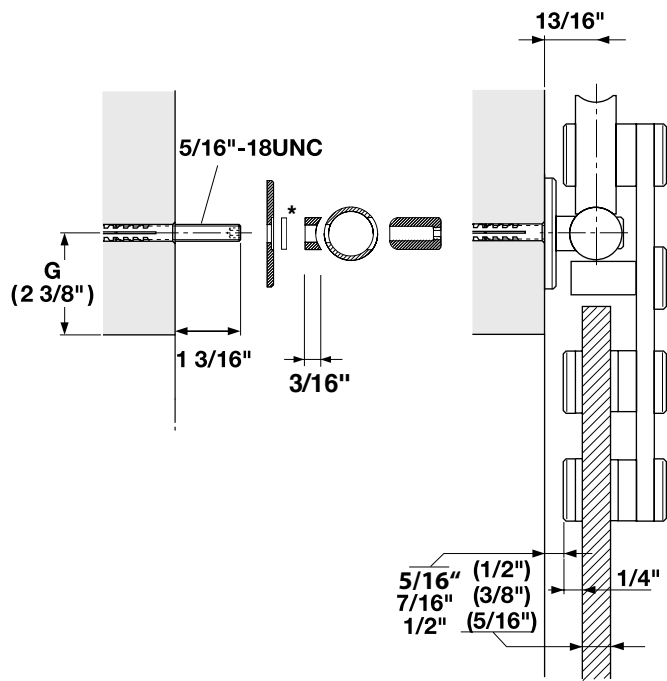

Installation with baseboards and trim

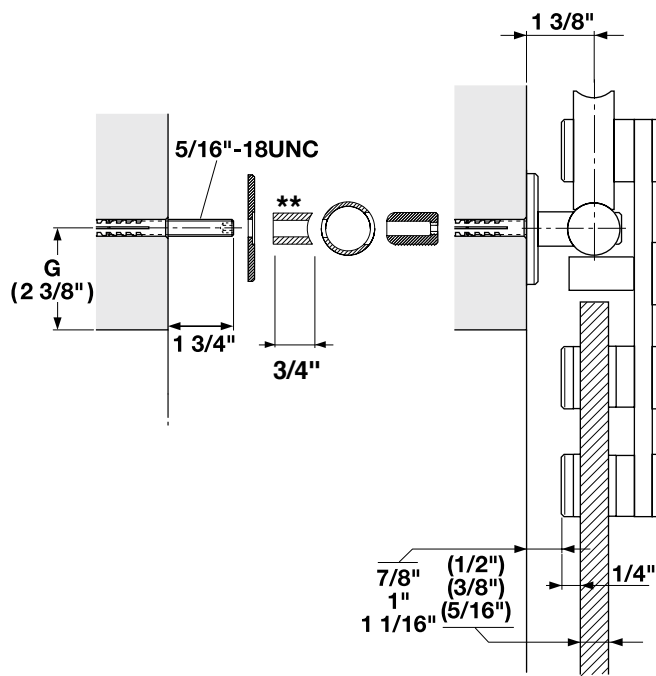

* Compensation discs $1/16''$, $3/16''$ and $3/8''$

To compensate for wall unevenness,
order separately.

(Only 1 piece per wall fixture!)

	Art.-No.	inches
	USO216-2EF	$1/16''$
	USO216-5EF	$3/16''$
	USO216-10EF	$3/8''$

** Spacers order separately.

	Art.-No.
	USO226-19EF

Sliding door fittings Flatec IV

for glass doors (5/16" - 1/2") - Preparation of glass door

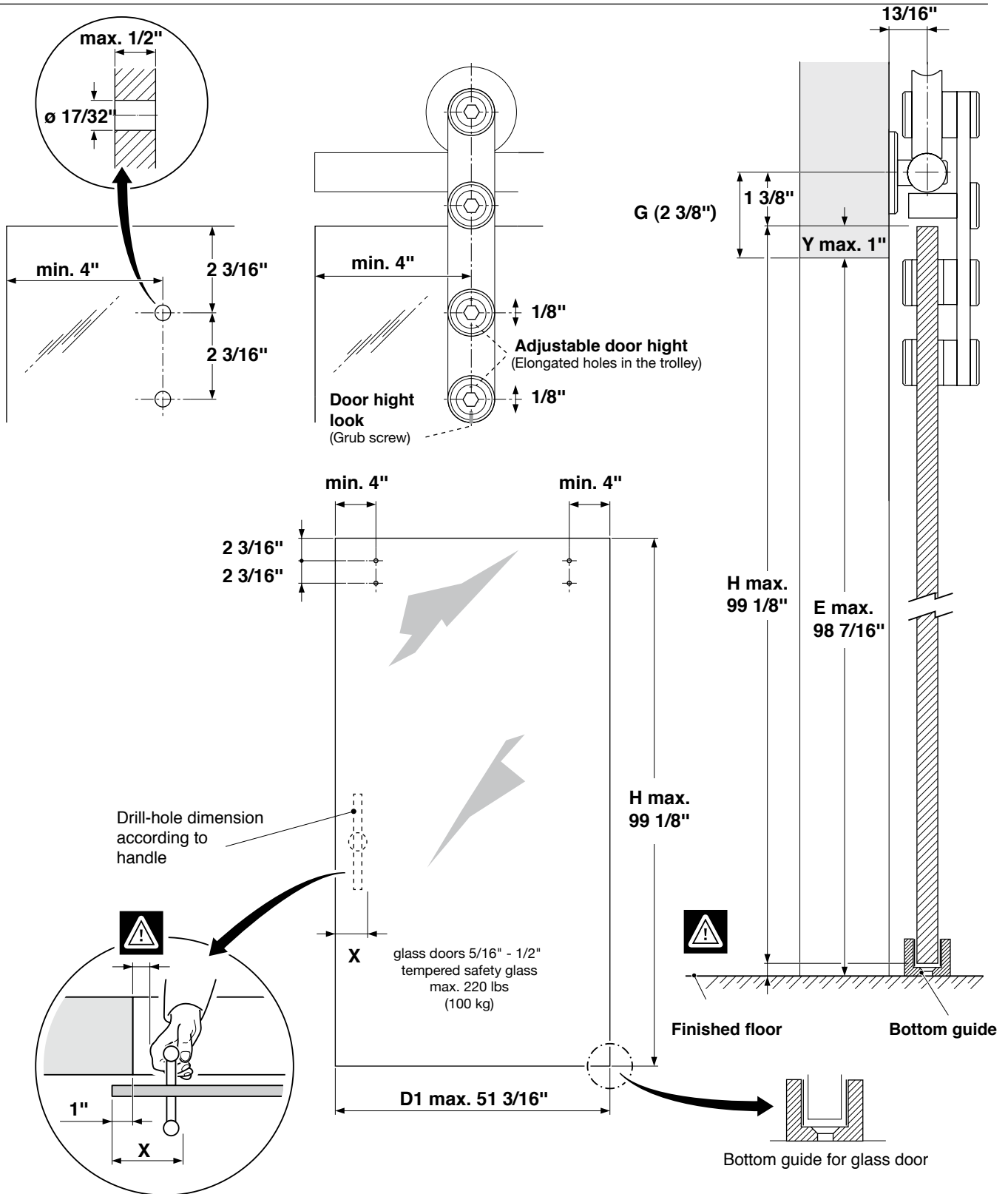

Make door handle clearance so that fingers do not get pinched when the door is used!

Sliding door fittings Flatec IV

for glass doors (5/16" - 1/2" thickness)

Required system parts

Please refer to the catalogue for article no's and models!

A Guide rail \varnothing 1 "



A1 Guide rail \varnothing 1 " for guide rail couplings



N Trolley complete

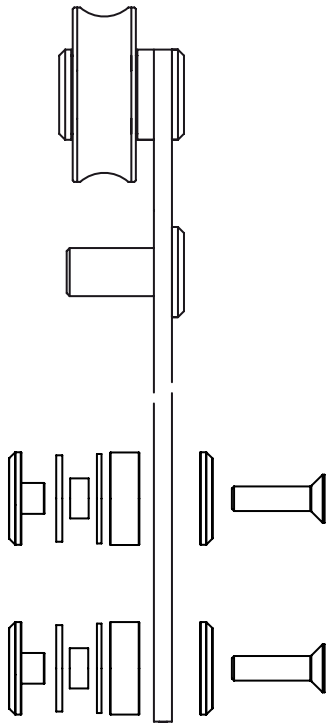

C Wall fixtures

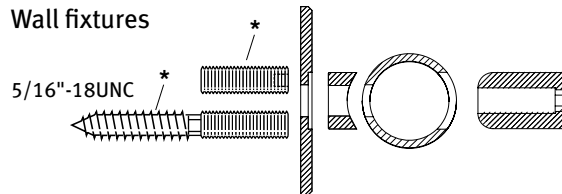

(without screws and dowels, at construction site)
* not included in scope of delivery.

M Door stoppers

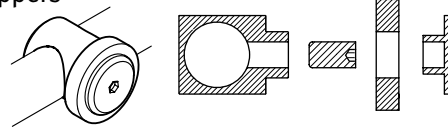

L Bottom guide
(without screws and dowels,
at construction site)

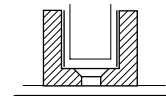

K Guide rail cupping

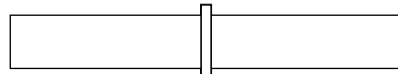

6 Special tool

