



How to Choose the Right In-Drawer Outlet

Thank you for your interest in including Docking Drawer outlets into your project. As the market leader of in-drawer outlet installations, we're happy share more details about choosing the right outlet for your project. We'll also share a few tips with you!

Getting Started

How will your in-drawer outlets be used?

Are you creating an in-drawer charging station to declutter your kitchen? Or are you wanting an in-drawer outlet to power your hair dryer, curling iron, or another small appliance? Docking Drawer manufactures two types of in-drawer outlets: Charging (Max Current = 3 amps) and Powering (Max Current = 20 amps).



Charging Outlets

Referred to as Docking Drawers, these outlets are designed to charge today's technology. They're commonly specified into kitchens, desks, mudrooms, closets, and nightstands to create a clutter-free charging space. Charging outlets feature a UL-Listed circuit breaker to prevent high-power devices from being used. This not only minimizes risk, it helps make our outlets much safer than common DIY outlet hacks found on Pinterest.

WARNING: Charging outlets will not power a hair dryer, mixer or other high-power devices.



Thermostat cuts power if surrounding temperature exceeds 120°F.



Powering Outlets

Also called Style Drawers, these outlets are usually specified into a bathroom vanity. They power hair dryers, curling irons, flat irons and more. All Style Drawer series in-drawer outlets feature a UL-Listed thermostat that cuts power to the outlet in the event that the surrounding temperature exceeds 120°F. This helps to minimize risk with devices that are accidentally left on or still plugged in when the drawer is closed.

Powering outlets are perfect for powering hair dryers, mixers and other high-power devices.



Measure Your Cabinet

Docking Drawer outlets come in a variety of sizes offering different ranges of extensions. Here is how to find the size that works for you.

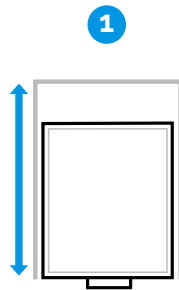

1 Start your project by measuring the cabinet depth.

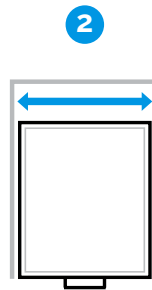

2 Measure the drawer box width (OD).

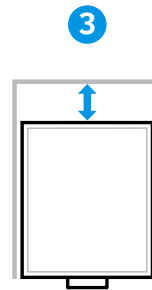

3 Then measure the space available behind the drawer box.

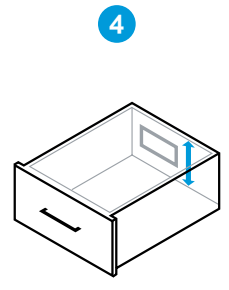



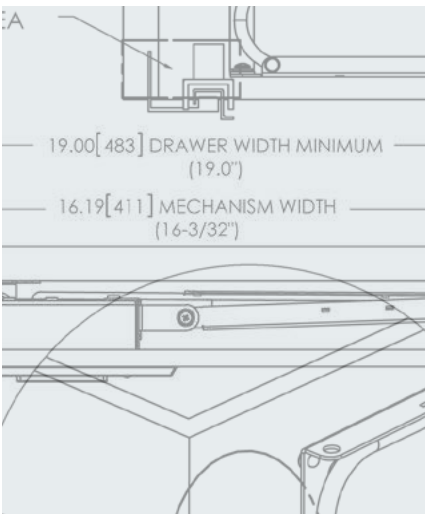

4 Then measure the interior drawer box height.



Start Planning a Project



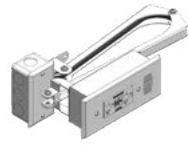

Planning an in-drawer outlet installation is easy using the resources provided by Docking Drawer, which can be found in our Specification Library at www.dockingdrawer.com. Mounting diagrams provide you or your installer with all measurements needed to plan an installation, while the Electrical Planning Guide details how to locate and connect Docking Drawer outlets to an in-cabinet power source.

	CHARGING			POWERING						
Outlet Type	Docking Drawer Blade™ 		Docking Drawer Blade Duo™ 	Style Drawer Blade™ 		Style Drawer Blade Duo™ 		Style Drawer Flush™ 		
Outlet Name	Blade	Blade USB	Duo	24 Blade	21 Blade	24 Blade Duo	21 Blade Duo	24 Flush	21 Flush	18 Flush
Part Number (ETL)	Hafele # 822.53.160/ 161/162 Blade # 0290-30000		Hafele # 822.53.166/ 167/168 Blade # 0290-30100	Hafele # 822.53.136/ 137/138 Blade # 0290-00324	Hafele # 822.53.133/ 134/135 Blade # 0290-00321	Hafele # 822.53.186/ 187/188 Blade # 0290-20324	Hafele # 822.53.183/ 184/185 Blade # 0290-20321	Hafele # 822.53.017/ 018/073 Blade # 0290-00033	Hafele # 822.53.019/ 020/072 Blade # 0290-00032	Hafele # 822.53.027/ 028/053 Blade # 0290-00050
Part Number (CSA)	Hafele # 822.53.163/ 164/165 Blade # 0290-30001									
Finish Choices	White, Black, Stainless Steel									

CABINET SPECIFICATIONS

Cabinet Depth	≤ 24"			≤ 24"	≤ 21"	≤ 24"	≤ 21"	≤ 24"	≤ 21"	≤ 18"
Minimum drawer box width (OD)	≥ 15"			≥ 16" if drawer box height is ≥ 5.25" ≥ 17.75" if drawer box height is ≥ 4"	≥ 14.5" if drawer box height is ≥ 5.25" ≥ 16.25" if drawer box height is ≥ 4"	≥ 16" if drawer box height is ≥ 5.25" ≥ 17.75" if drawer box height is ≥ 4"	≥ 14.5" if drawer box height is ≥ 5.25" ≥ 16.25" if drawer box height is ≥ 4"	≥ 13.5"	≥ 12"	≥ 10.5"
Minimum space behind drawer box	2"			2"			5"			
Minimum interior drawer box height	3"			4" - 5.25"			4"			

Features:	AC/USB		ALL USB	GFCI						
ETL Listed to UL962a	Yes			Yes						
ETL Listed to CSA - 22.2	No	Yes		No						
Interlocking Safety Feature	Circuit Breaker			Manual Reset Thermostat						
Electrical Connection	4 1/2' cord with a NEMA 5-15P plug			Hardwired						
Warranty	2 Years									

Receptacle:	CHARGING			POWERING					
									
Tamper Resistant	Yes	Yes	NA	Yes		Yes			
120V AC Outlets	2	2	0	2		2			
USB Ports	2 USB-C (PD)	2 USB-A	4 USB-A	0		2 USB-A			
GFCI	0			2		Yes (Inline to GFCI outlet)			
Max Current	AC: 3 amps @ 120 VAC USB (PD Device): 2 amps @ 15 VDC 3 amps @ 9 VDC USB (Non-PD Device): 3 amps @ 5 VDC	AC: 3 amps @ 120 VAC USB: 3 amps @ 5 VDC	4.2 amps @ 5 VDC	20 amps		AC: 20 amps @ 120 VAC (Combined) USB 3.6 amps @ 5 VDC			
LED Indicator	No			Yes		No			

09/17/19 AG