

# Docking Drawer™

## Style Drawer Blade™ and Flush™ Installation Instructions

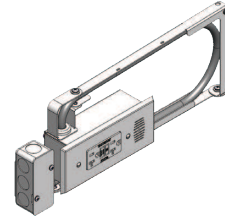

**HÄFELE #:**  
822.53.133/134/135  
822.53.136/137/138

**STYLE DRAWER BLADE PART #:**  
0290-00324  
0290-00321

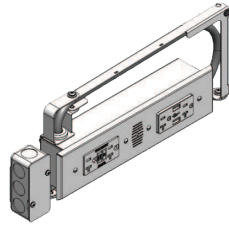

**HÄFELE #:**  
822.53.186/187/188  
822.53.183/184/185

**STYLE DRAWER BLADE DUO PART #:**  
0290-20324  
0290-20321

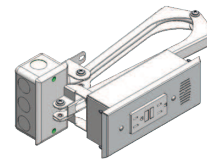

**HÄFELE #:**  
822.53.017/018/073  
822.53.019/020/072  
822.53.027/027/053

**STYLE DRAWER FLUSH PART #:**  
0290-00033  
0290-00032  
0290-00050

• It is the installer's responsibility to make sure that power supplied to the junction box conforms to all applicable building codes and standards.

• The Style Drawer series outlets must be connected to a 20A circuit using 12 AWG wire.

### Time Required - 30 min

- Tools Needed:**
- Screwdriver
  - Jigsaw
  - Drill
  - Measuring Tape
  - Square
  - Pencil
  - Cutout Template

### NOTICE

For Style Drawer Blade installations with optional Interlock Box, see addendum installation manual before starting the outlet installation.



**CAUTION - READ CAREFULLY**

- Failure to follow these instructions can cause death or permanent injury. Do not work on live electrical circuits! Make absolutely certain power is off before connecting the device!
- This product is for dry, indoor and permanent installations only.
- Install the device in accordance with all national and local electrical codes.
- This manual is for **POWERING** outlets only.

## How to Install the Outlet

**Step 1 -** Verify the drawer dimensions. Style Drawer Blade and Blade Duo require at least 2" behind the drawer box and Flush needs at least 5" behind the drawer box.

≥16" min drawer box width if drawer box height is ≥ 5.25"  
≥17.75" min drawer box width if drawer box height is ≥4"

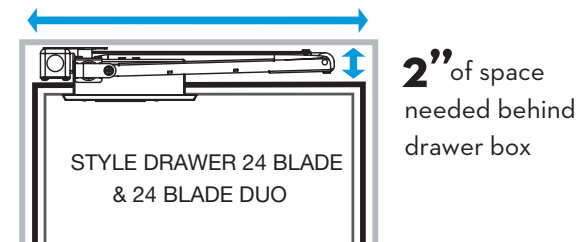

≥14.5" min drawer box width if drawer box height is ≥ 5.25"  
≥16.25" min drawer box width if drawer box height is ≥4"

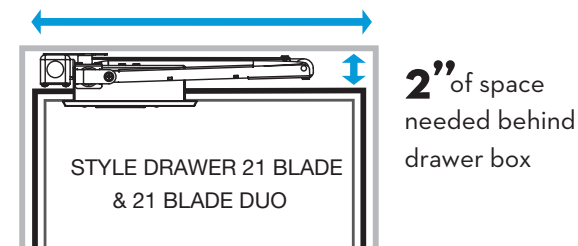

≥13.5" min drawer box width for 24 Flush  
≥12" min drawer box width for 21 Flush  
≥10.5" min drawer box width for 18 Flush

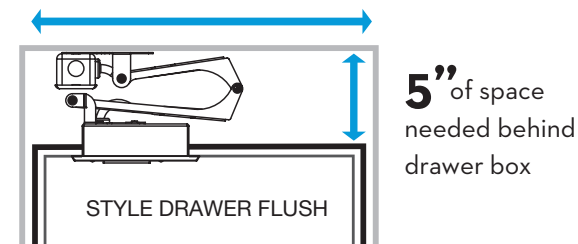

**Step 2 -** Remove the cutout template and flip to the side that corresponds with your product's part number.

### Step 3 -

Locate the proper location for the receptacle box cutout using our cutout template. You can locate the proper location of the drawer box, making sure that the arms will not interfere with the slides and that there is enough material surrounding the receptacle box to securely hold it in place.

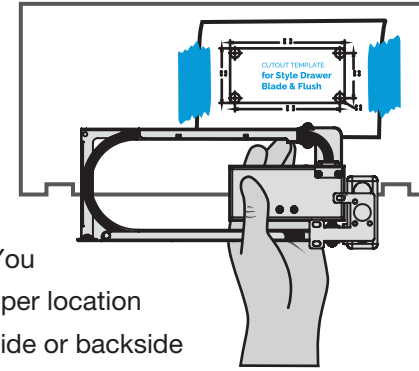

**Step 4 -** With a 1/2" drill bit, drill a hole in each corner, being careful not to splinter the wood on the inside of the drawer box. Using one of the 1/2" holes, insert a jigsaw and then make the required cutouts in the drawer box.

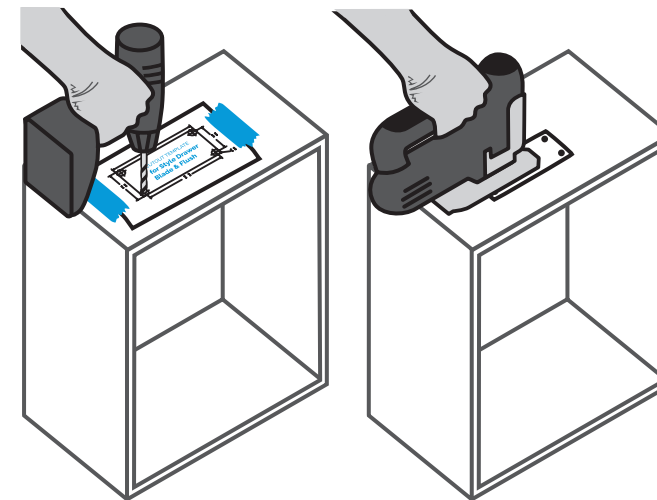

**Step 5 -** Reinstall the drawer box and slide the Style Drawer receptacle box through the cutout. Secure it with the 4 wood screws provided.

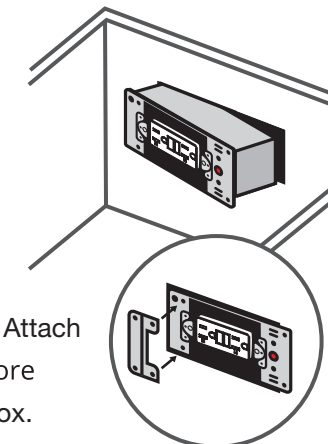

**Note for Blade outlets:** Attach the mounting flange before securing the receptacle box.

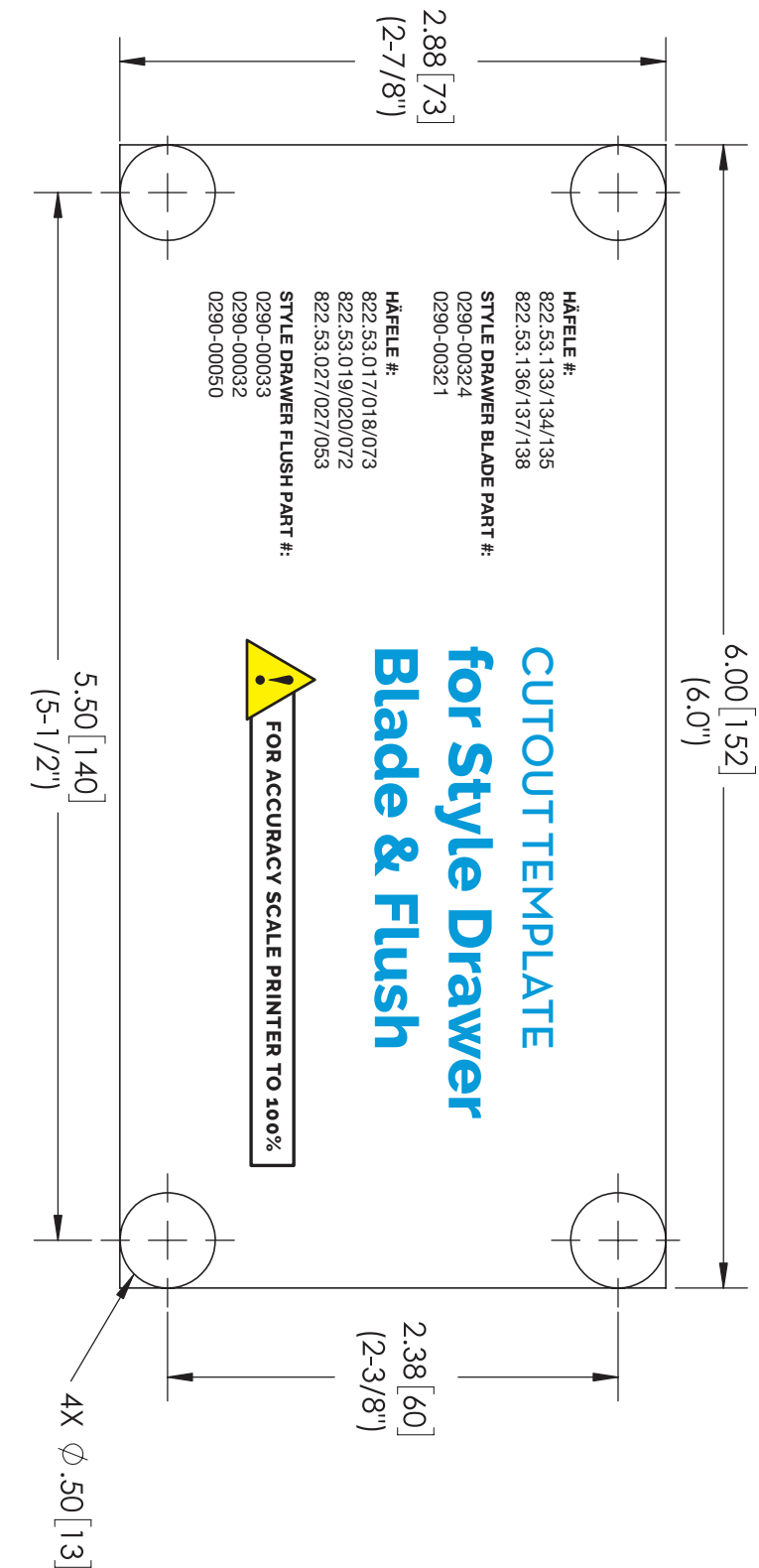

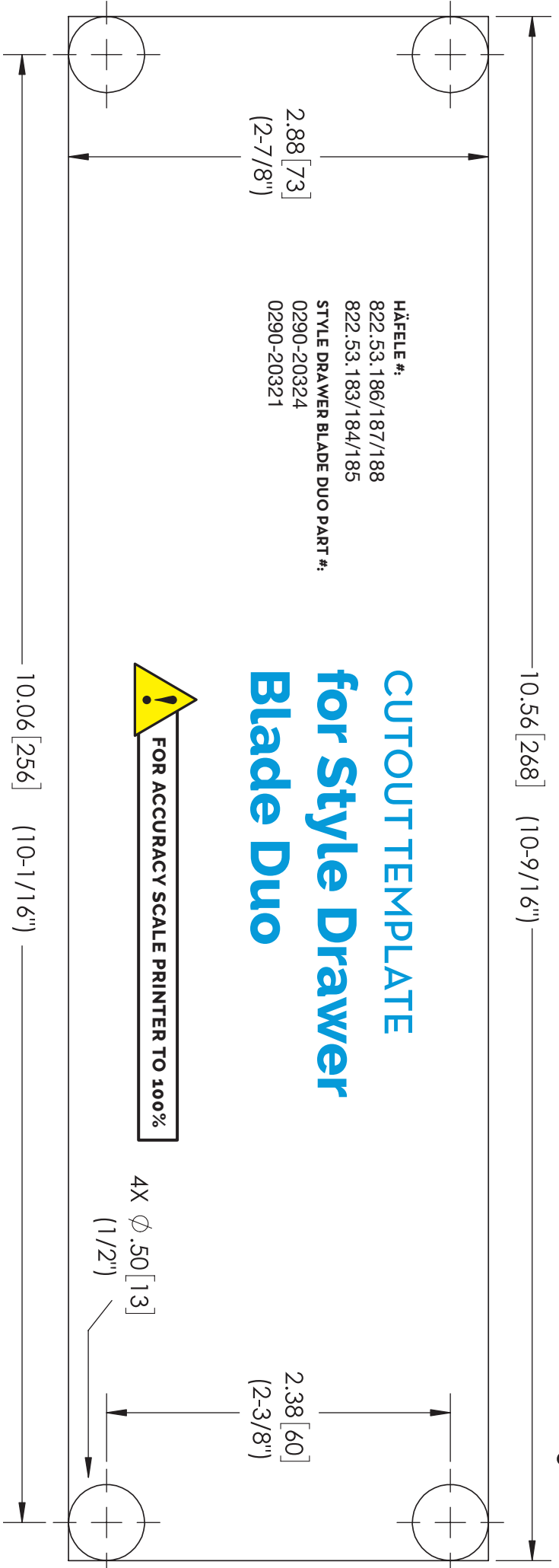

HÄFELE #:  
 822.53.186/187/188  
 822.53.183/184/185  
 STYLE DRAWER BLADE DUO PART #:  
 0290-20324  
 0290-20321

**CUTOUT TEMPLATE**  
**for Style Drawer**  
**Blade Duo**

**FOR ACCURACY SCALE PRINTER TO 100%**

4X Ø .50 [13]  
 (1/2")

2.38 [60]  
 (2-3/8")

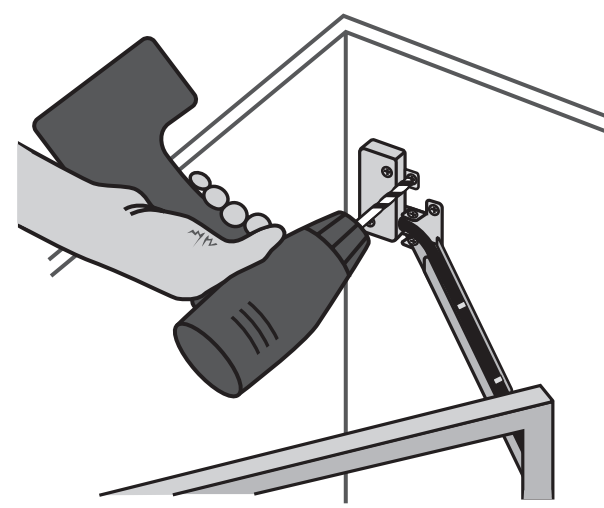

**Step 6 -** Align arms. With the drawer mostly closed, mark the position of the rear mounting bracket. It is important to make sure the drawer moves freely in and out and that the arms are square and even. Spend sufficient time at this step before fastening the bracket to the rear wall to make sure everything is square and the arms are in the correct position. Once that is done, secure with the screws provided.

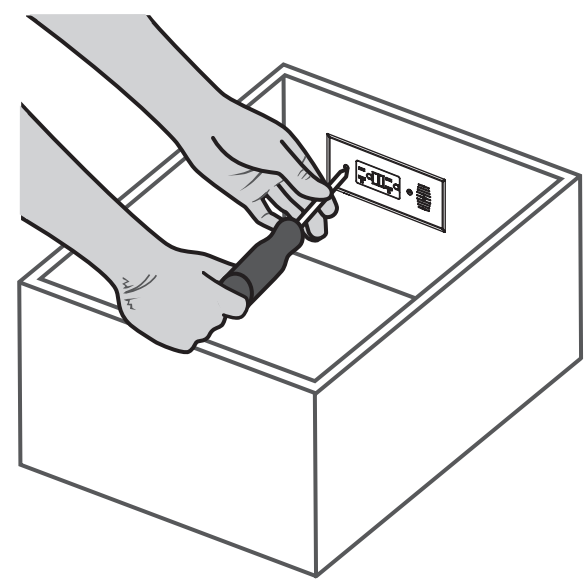

**Step 7 -** Install the cover plate.



**Step 8 -** Connect electrical supply to the Style Drawer outlet according to the wiring diagram on opposite page. For more details about locating an in-cabinet electrical supply for your Docking Drawer installation, please refer to the Electrical Planning Guide located in the Specification Library at [www.dockingdrawer.com](http://www.dockingdrawer.com).

-  **Green Wire (Ground): Green Screw**
-  **White Wire (Neutral): Silver Screw**
-  **Black Wire (Line): Brass Screw**

**Receptacle Box Wiring**

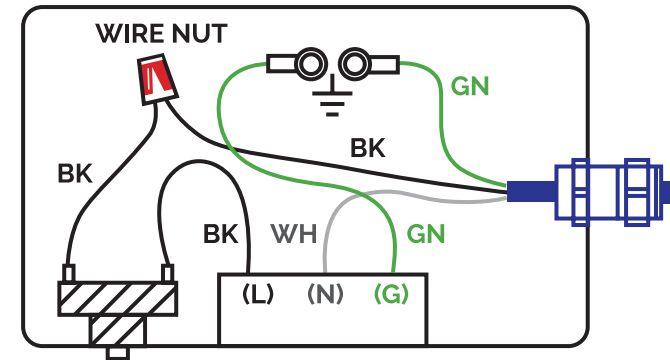

Note: For a successful Style Drawer Series installation, it is NOT necessary to touch anything inside the receptacle box. However, if the outlet needs to be removed, reference the above diagram.

**Junction Box Wiring**

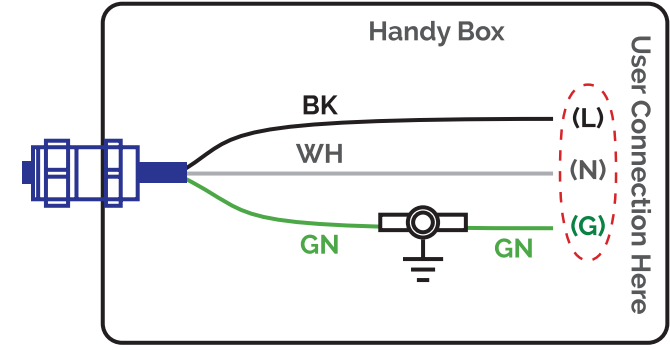

**How to Operate the Outlet**

The Style Drawer Series outlets include a 100°-120°F resettable thermostat to protect against overheating inside the drawer. To reset, correct the source of over temperature and push the button in the center of the vents of the cover plate. Note: You may need to wait a few minutes for the unit to cool before the thermostat can be reset.

The GFCI outlet has a green LED which will light if there is power to the outlet. If the LED is not lit, check the GFCI reset button, the thermostat, and that the line, neutral, and ground wires are connected properly.

**Docking Drawer™**  
 Complete Outlet Lineup

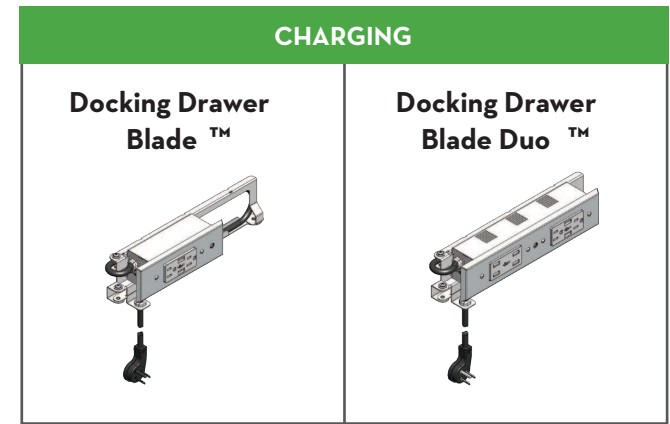

Max output: 3 amps. Perfect for charging cell phones, tablets, and laptops.

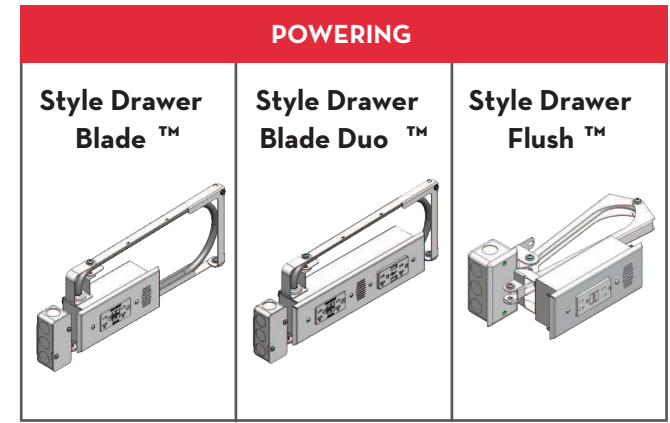

Max output: 20 amps, GFCI outlets. Perfect for powering hair dryers, curling irons, and small kitchen appliances.

**Docking Drawer™**

**Have questions? Need help? Call us!**

-  (530) 205-3625
-  12893 Alcosta Blvd, Suite M, San Ramon, CA 94583
-  [sales@dockingdrawer.com](mailto:sales@dockingdrawer.com)
-  [www.dockingdrawer.com](http://www.dockingdrawer.com)