

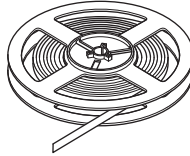

LED2062 **LED3045**
LED2065 **LED3048**
LED2068 **LED3050**
LED2077 **LED3051**
LED3042 **LED3052**

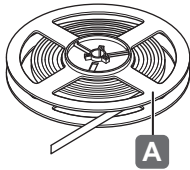

833.74.3xx
833.76.3xx



+

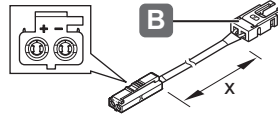

x	12V
100	833.93.736
500	833.95.701
2000	833.95.700

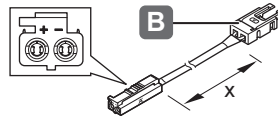

x	24V
100	833.75.743
500	833.95.707
2000	833.95.706

732.28.341

+

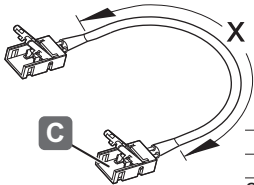

x	12/24V
50	833.89.191
500	833.89.192
2000	833.89.193

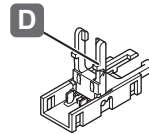

833.89.206

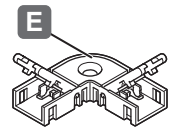

833.89.187

HDE 24.08.2020

	12/24 V System	W/m	← max. (m) →					5.000 x 8 x 1,3	T _A
			20W	40W	60W	90W	270W		
12V	LED2062	4,8	4,1	8,3	12,5			-20 °C – +45 °C -4 °F – +113 °F	
	LED2065	4,8	4,1	8,3	12,5				
	LED2068	9,6	2,0	4,1	6,2				
	LED2077	9,6	2,0	4,1	6,2				
24V	LED3042	4,8	4,1	8,3		17,7	17,7		
	LED3045	9,6	2,0	4,1		9,3	9,3		
	LED3048	14,4	1,3	2,7		6,2	6,2		
	LED3050	9,6	2,0	4,1		9,3	9,3		
	LED3051	14,4	1,3	2,7		6,2	6,2		
	LED3052	19,2	1,0	2,0		4,6	4,6		

i



100 - 240 V~

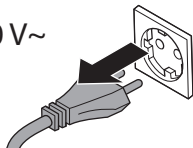

1

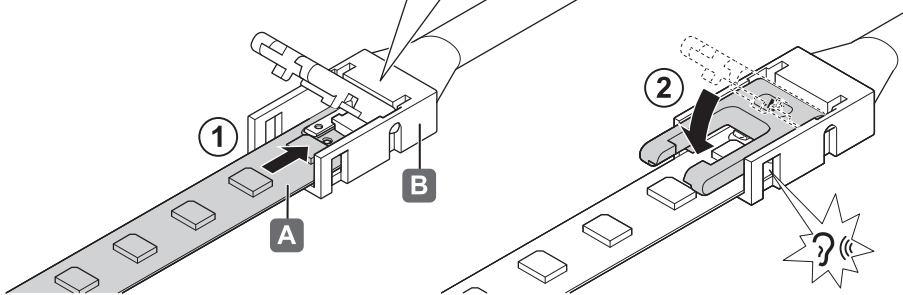
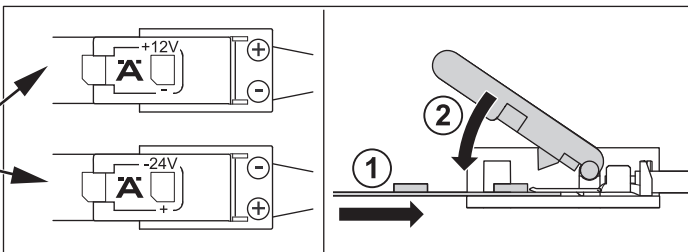
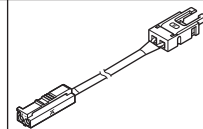
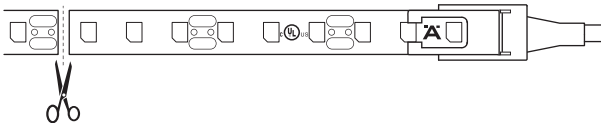

+

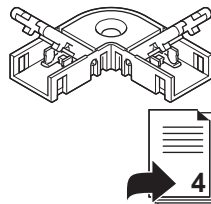
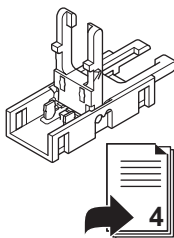
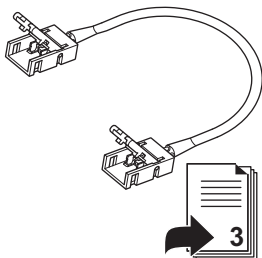

732.26.341

HDE 24.08.2020

2

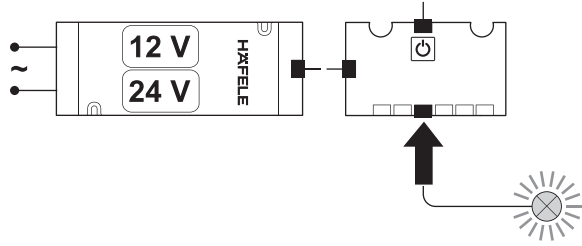

732.28.341

+

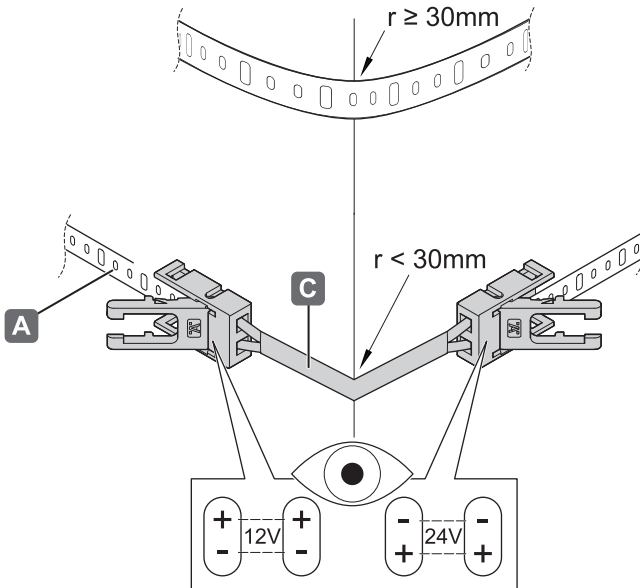
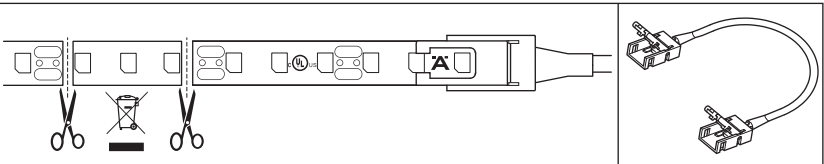

HDE 24.08.2020

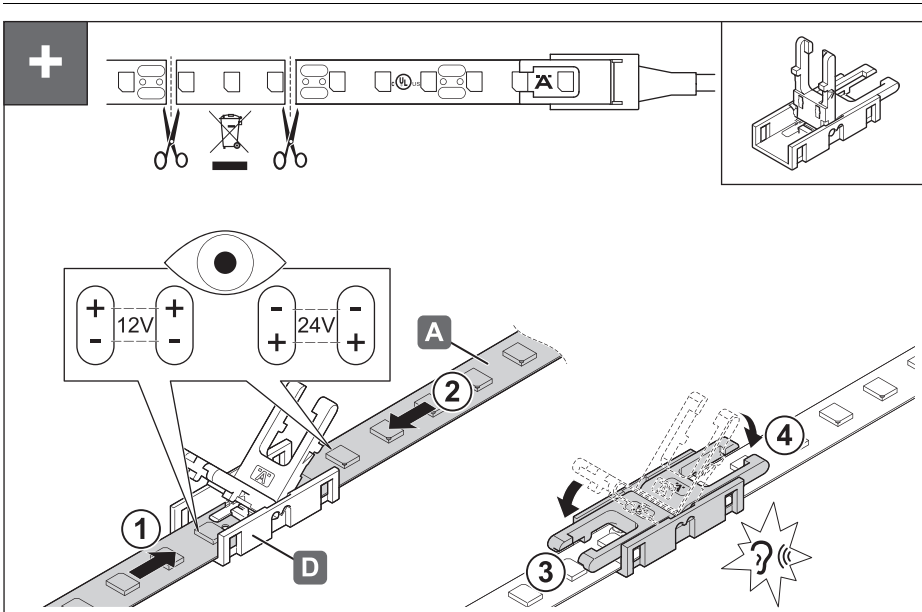

732.26.341

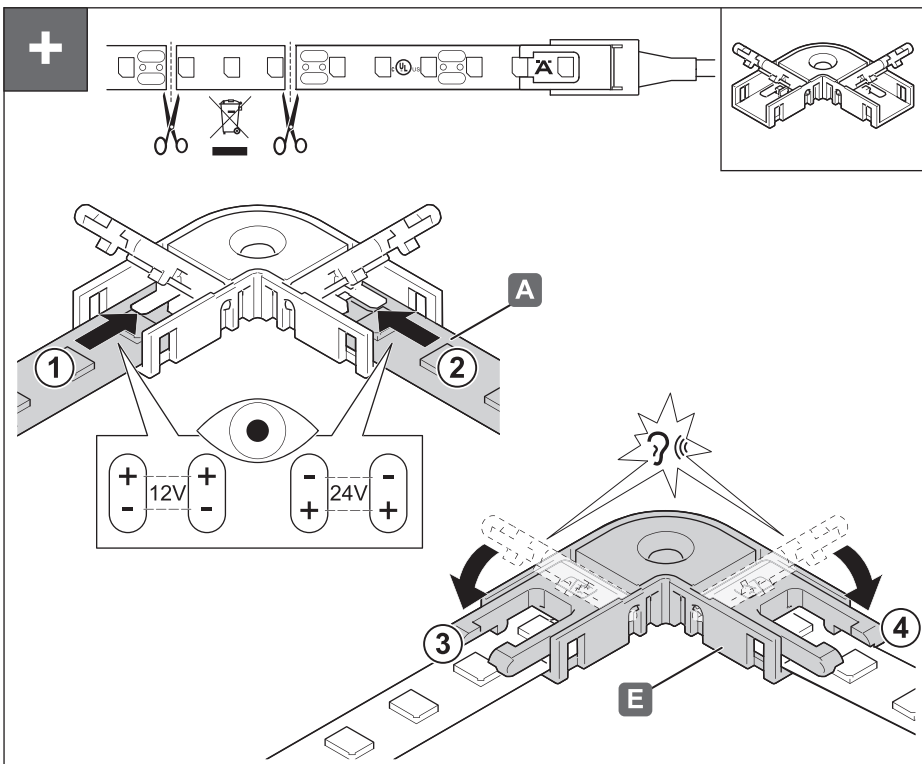

HDE 24.08.2020