

TECHNICAL DATA SHEET

LOW OVERHEAD APPLICATION

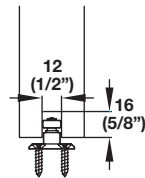
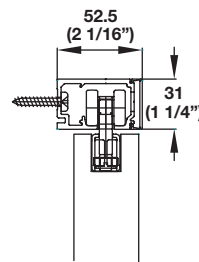
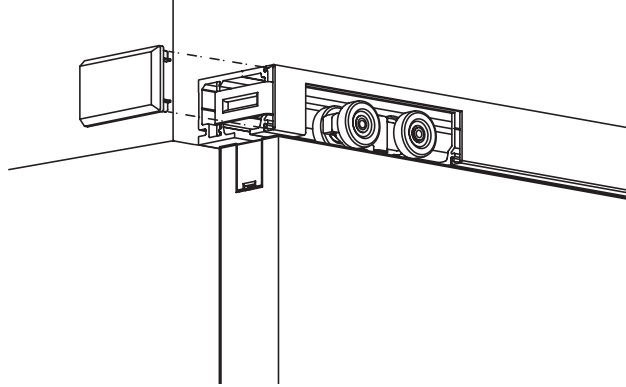

For any additional information please contact:

Ty LeFever | Tel: (815) 315-3410 | Email: ty.lefever@hafele.us

TECHNICAL DATA SHEET (continued)

HAWA PORTA 60 HMD FITTING SET







with 78 3/4" Wall Mounted Upper Track

Item No. 940.60.116

HAWA PORTA 100 HMD FITTING SET

with 78 3/4" Wall Mounted Upper Track

Item No. 941.00.116

Accessories					
Door Pulls with Through Bolts - ADA Compliant					
	BACK TO BACK PULL	SINGLE THROUGH MOUNT		BACK TO BACK PULL	SINGLE THROUGH MOUNT
Material: Zinc, stainless steel matt			Material: Zinc, black		
CTC: 192 mm	Item No. 902.00.700	Item No. 902.00.710	CTC: 192 mm	Item No. 902.00.701	Item No. 902.00.702
CTC: 384 mm	Item No. 901.00.576	Item No. 901.00.586	CTC: 384 mm	Item No. 901.00.573	Item No. 901.00.583
FLUSH PULL - Glue-in type			POCKET DOOR JAMB LOCK, OPTIONAL		
					
H x W: 150 x 50 mm Material: Stainless Steel, matt Item No. 902.01.522	H x W: 150 x 50 mm Material: Stainless Steel, black, powder coated Item No. 902.01.524	Material: Brass, brushed chrome Item No. 911.26.251 Supplied with: 2 screws, strike plate, safety hole release protector			

For any additional information please contact:

Ty LeFever | Tel: (815) 315-3410 | Email: ty.lefever@hafele.us